

Neenah R-4990-CX Unbolted

Series

R-4990-CX

Cut Sheet

12" Wide Unbolted

12" Wide NEENAH Unbolted Heavy Duty Trench Drain Grates and Frames

Product ID: R-4990-CX

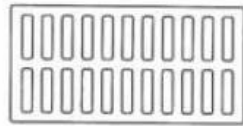
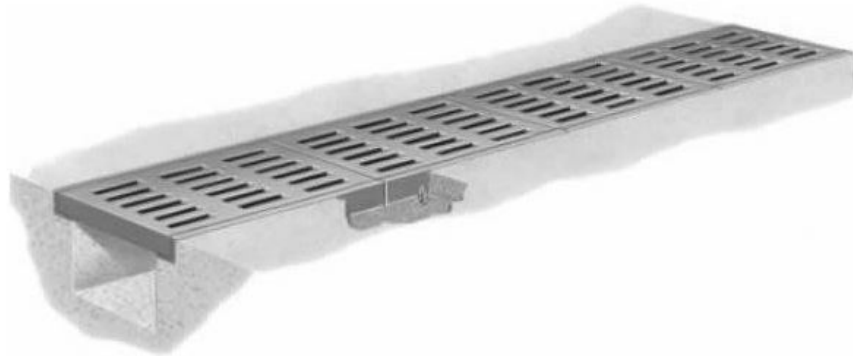

TYPE A
GRATE OPENINGS

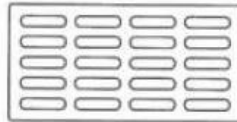

TYPE C
GRATE OPENINGS

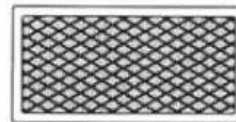

TYPE D
SOLID LID

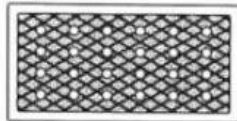

TYPE E
VENTED LID

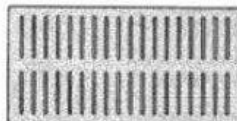

TYPE P
GRATE OPENINGS

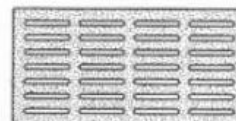

TYPE Q
GRATE OPENINGS

12" Wide Unbolted Neenah R-4990-CX Series Trench Grate

12"W X 24"L X 1 1/2"D

Choose Type A,C,D,E,P,Q

Materials: All frames and grates/lids are furnished standard in gray iron, meeting ASTM-A48 Class 35-B for heavy-duty use. In Type A and P grates the slots are perpendicular to the trench run. In Type C and Q grates the slots are parallel with the trench run.

Neenah recommends project designers avoid the use of light duty trench installations because it is likely that applications will be subjected to heavy delivery vehicle traffic at some time. Furthermore, the use of a site could be changed to heavy duty use patterns at some unanticipated future date.



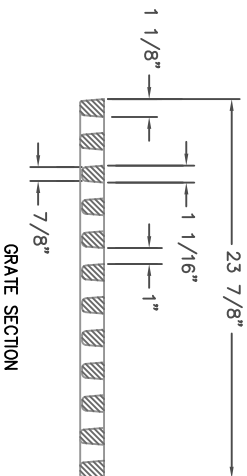
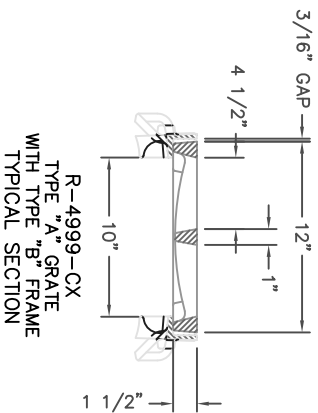
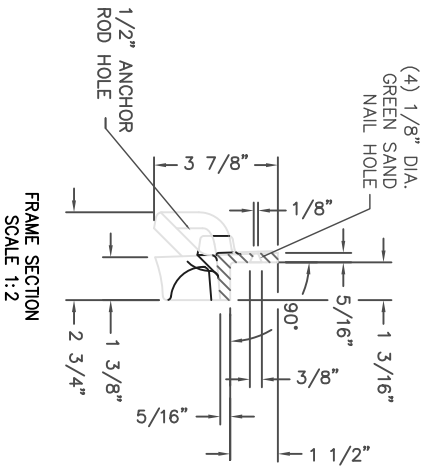
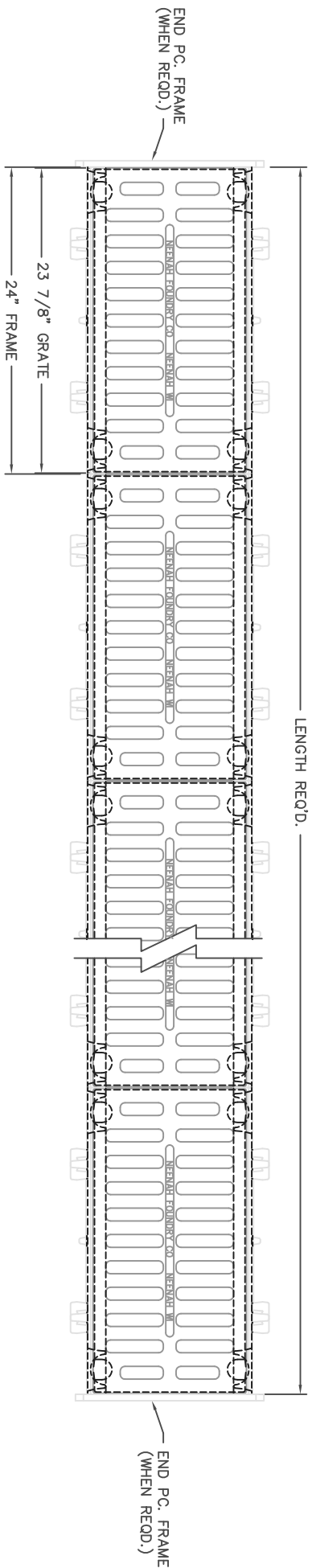

TRENCHDRAIN SUPPLY
 877-903-7246
 www.trenchdrainsupply.com

NOTES: FRAMES AND COVERS ARE FURNISHED IN STANDARD 2'-0" INCREMENTS. SPECIAL LENGTH FRAMES AND COVERS ARE FURNISHED FOR ANY OVERALL LENGTH.
 COMPONENT NOS.: GRATE 4990-3121, SIDE PC. FRAME 4999-2415,
 END PC. FRAME 4990-3112 (IF REQUIRED)
 MATERIAL: SIDE PC. FRAMES - CAST GRAY IRON ASTM A-48, CLASS 35A
 END PC. FRAMES AND GRATES - CAST GRAY IRON ASTM A-48, CLASS 35B
 FINISH: NO PAINT

DR.	RKB	SCALE	TITLE
CH.		1/8"=1"	R-4990-CX TRENCH ASSEMBLY
APP.			TYPE "A" GRATE WITH TYPE "B" FRAME
DATE	09-20-2010	DIM CHK.	NEENAH
REVISION	UPDATED DWG. WITH NEW FRAME		FOUNDRY COMPANY
			NEENAH WISCONSIN 54956
			NEENAH
			NF-4990CX A B

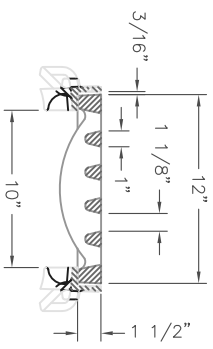
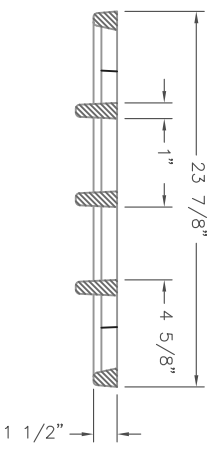
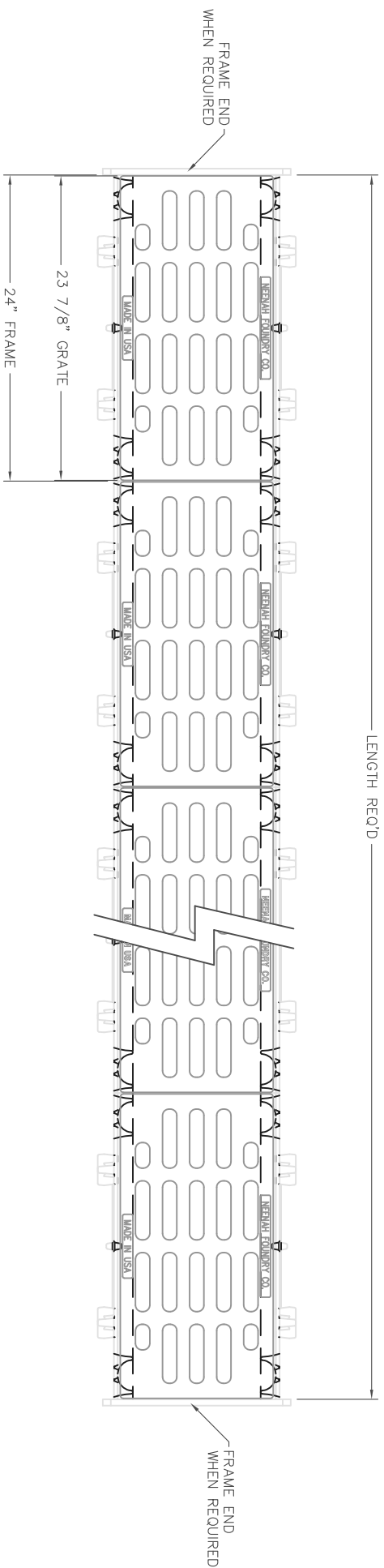

R-4999-CX
TYPE "C" GRATE
WITH TYPE "B" FRAME
TYPICAL SECTION

Supplied By:

TRENCH DRAIN SUPPLY
877-903-7246
www.trenchdrainsupply.com

NOTES: FRAMES AND GRATES ARE FURNISHED IN STANDARD 2'-0" INCREMENTS. SPECIAL LENGTH FRAMES AND COVERS ARE FURNISHED FOR ANY OVERALL LENGTH.
COMPONENT NOS.: GRATE 4990-3123, SIDE PC. FRAME 4999-2415,
END PC. FRAME 4990-3112 (WHEN REQ'D)
MATERIAL: SIDE PC. FRAMES - CAST GRAY IRON ASTM A-48, CLASS 35A
END PC. FRAMES AND LIDS - CAST GRAY IRON ASTM A-48, CLASS 35B
FINISH: NO PAINT UNLESS SPECIFIED ON PURCHASE ORDER

DR.	CAG	SCALE	TITLE
CH.	RKB	1/8"=1'	R-4990-CX TYPE "B" FRAME AND TYPE "C" GRATES
APP.	SPT	NEENAH FOUNDRY	
DATE	12/2/2013	NEENAH WISCONSIN 54956 PHONE 800-558-5075 LINCOLN, NEBRASKA 68529 PHONE 800-234-7466	
www.neenahfoundry.com		NF-4990CX C B	

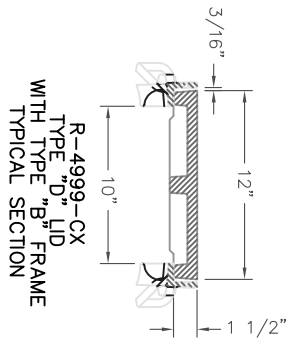
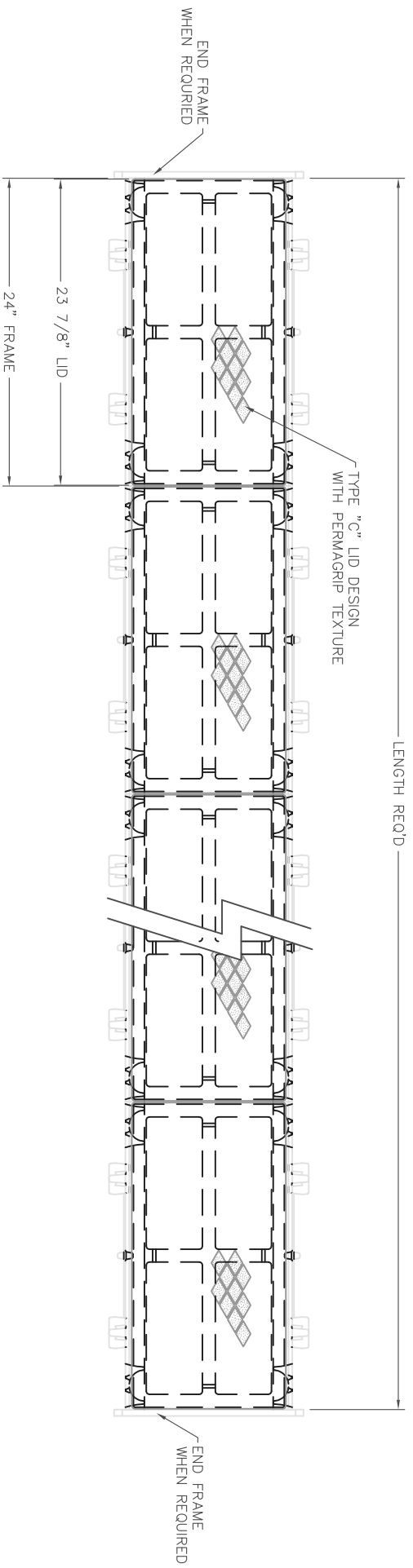

R-4999-CX
TYPE "D" LID
WITH TYPE "B" FRAME
TYPICAL SECTION

Supplied By:

TRENCH DRAIN SUPPLY
877-903-7246
www.trenchdrainsupply.com

NOTES: FRAMES AND LIDS ARE FURNISHED IN STANDARD 2'-0" INCREMENTS. SPECIAL LENGTH FRAMES AND COVERS ARE FURNISHED FOR ANY OVERALL LENGTH.
COMPONENT NOS.: LID 4990-3124, SIDE P.C. FRAME 4999-2415,
END P.C. FRAME 4990-3112 (WHEN REQ'D)
MATERIAL: SIDE P.C. FRAMES - CAST GRAY IRON ASTM A-48, CLASS 35A
END P.C. FRAMES AND LIDS - CAST GRAY IRON ASTM A-48, CLASS 35B
FINISH: NO PAINT UNLESS SPECIFIED ON PURCHASE ORDER

DR.	CAG	SCALE	TITLE:
CH.	RKB	1/8"=1'	R-4990-CX
APP.	SPT		TYPE "B" FRAME WITH TYPE "D" LID
DATE	12/2/2013		
www.trenchdrainsupply.com		NEENAH FOUNDRY	
		NEENAH WISCONSIN 54956 PHONE 800-558-5075 LINCOLN, NEBRASKA 68529 PHONE 800-234-7466	
			NF-4990CX D B

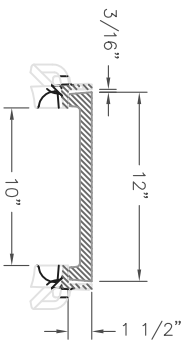
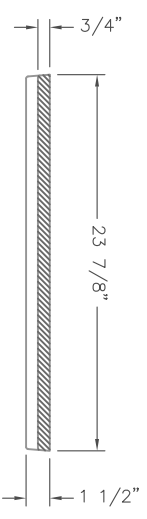
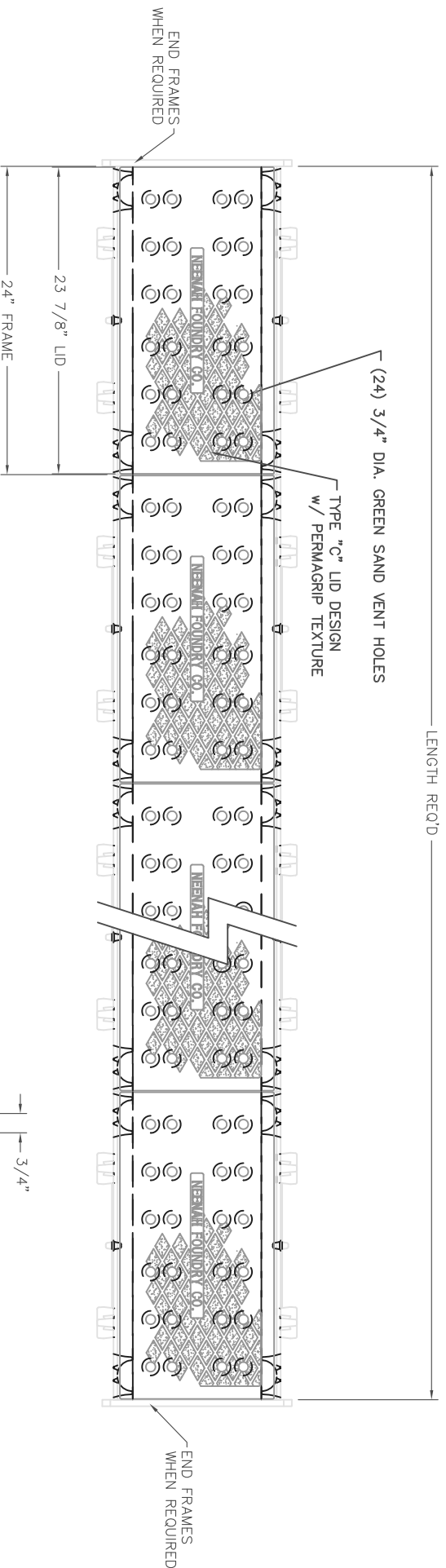

R-4999-CX
TYPE "E" LID
WITH TYPE "B" FRAME
TYPICAL SECTION

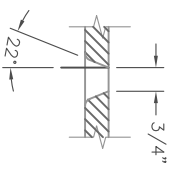

VENT HOLE DETAIL
SCALE 1:4

NOTES: FRAMES AND LIDS ARE FURNISHED IN STANDARD 2'-0" INCREMENTS. SPECIAL LENGTH FRAMES AND COVERS ARE FURNISHED FOR ANY OVERALL LENGTH.
 COMPONENT NOS.: LID 4990-3125, SIDE PC. FRAME 4999-2415,
 END PC. FRAME 4990-3112 (WHEN REC'D)
 MATERIAL: SIDE PC. FRAMES - CAST GRAY IRON ASTM A-48, CLASS 35A
 END PC. FRAMES AND LIDS - CAST GRAY IRON ASTM A-48, CLASS 35B
 FINISH: NO PAINT UNLESS SPECIFIED ON PURCHASE ORDER

CAD DWG. REF: 4990CX EDWG-1

TRENCH DRAIN SUPPLY
 877-903-7246
 www.trenchdrainsupply.com

DR.	CAG	SCALE	TITLE	R-4990-CX
CH.	RKB	1/8"=1"	TYPE "B" FRAME WITH TYPE "E" VENTED LID	
APP.	SPT			
DATE	12/2/2013			
www.neenahfoundry.com		NEENAH FOUNDRY NEENAH WISCONSIN 54956 PHONE 800-558-5075 LINCOLN, NEBRASKA 68529 PHONE 800-234-7466		
				NF-4990CX E B

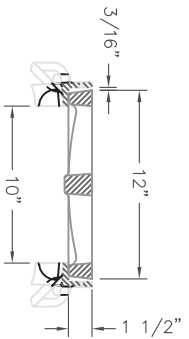
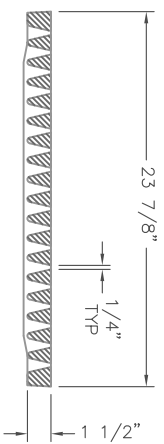
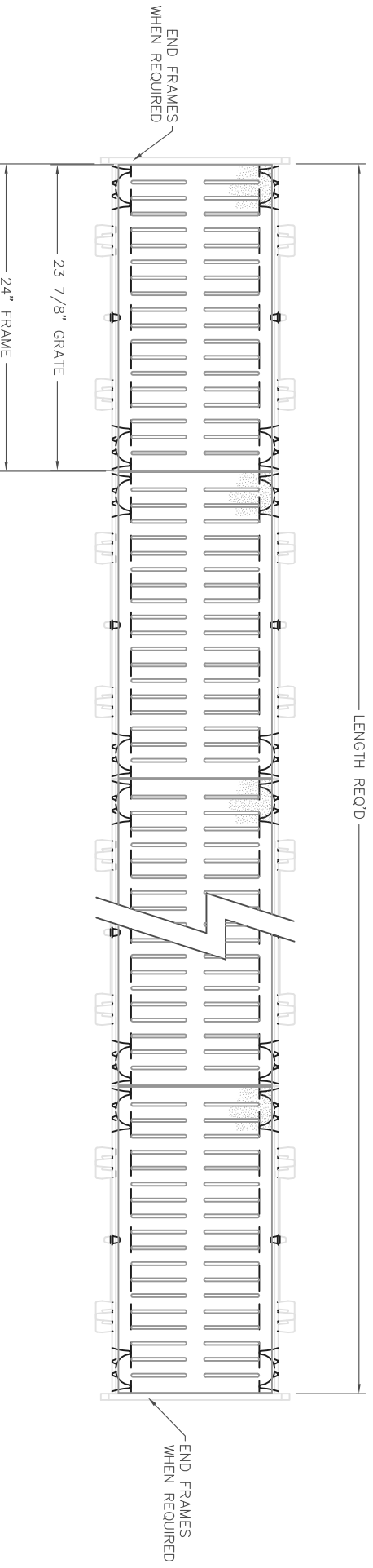

R-4990-CX
TYPE "P" GRATE
WITH TYPE "B" FRAME
TYPICAL SECTION

Supplied By:

TRENCH DRAIN SUPPLY
877-903-7246
www.trenchdrainsupply.com

NOTES: FRAMES AND LIDS ARE FURNISHED IN STANDARD 2'-0" INCREMENTS. SPECIAL LENGTH FRAMES AND COVERS ARE FURNISHED FOR ANY OVERALL LENGTH.
COMPONENT NOS.: GRATE 4990-3129, SIDE P.C. FRAME 4999-2415, END P.C. FRAME 4990-3112 (WHEN REQ'D)
MATERIAL: SIDE P.C. FRAMES - CAST GRAY IRON ASTM A-48, CLASS 35A
END P.C. FRAMES AND GRATINGS - CAST GRAY IRON ASTM A-48, CLASS 35B
FINISH: NO PAINT UNLESS SPECIFIED ON PURCHASE ORDER

DR.	CAG	SCALE	TITLE
CH.	RKB	1/8"=1"	TYPE "B" FRAME WITH TYPE "P" GRATE
App.	SPT	NEENAH FOUNDRY	
DATE	6/2/2014	NEENAH WISCONSIN 54956 PHONE 800-558-5075 LINCOLN, NEBRASKA 68529 PHONE 800-234-7466	
www.neenahfoundry.com		NF-4990CX P B	

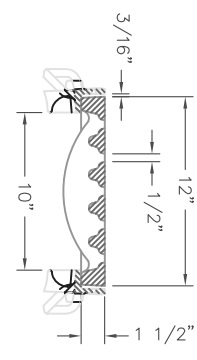
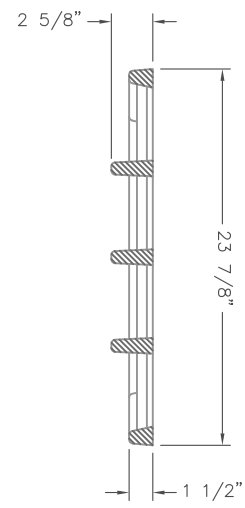
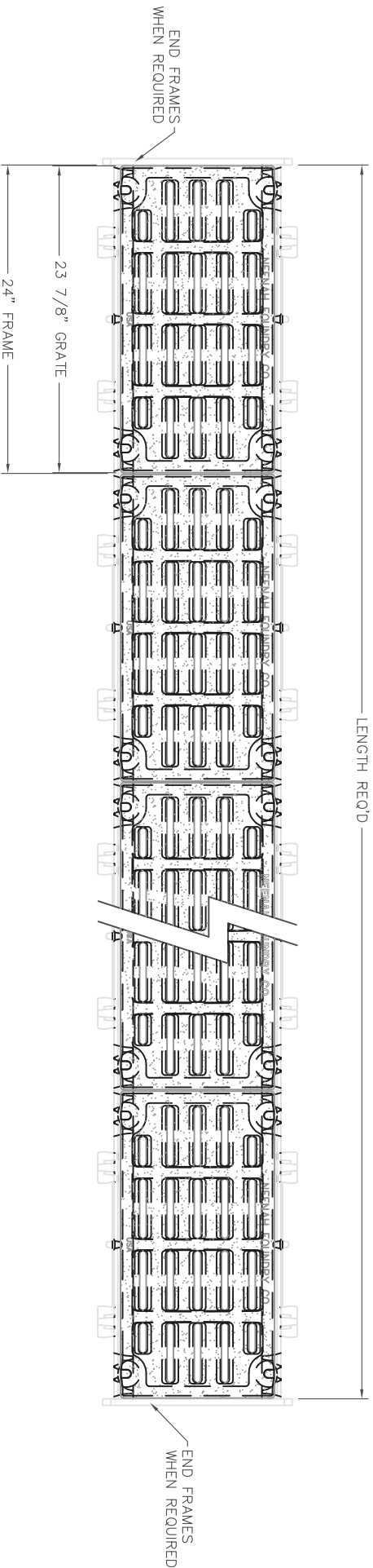

R-4990-CX
 TYPE "Q" GRATE
 WITH TYPE "B" FRAME
 TYPICAL SECTION

Supplied By:

TRENCH DRAIN SUPPLY
 877-903-7246
 www.trenchdrainsupply.com

NOTES: FRAMES AND LIDS ARE FURNISHED IN STANDARD 2'-0" INCREMENTS. SPECIAL LENGTH FRAMES AND COVERS ARE FURNISHED FOR ANY OVERALL LENGTH.
 COMPONENT NOS.: GRATE 4990-3127, SIDE PC. FRAME 4999-2415,
 END PC. FRAME 4990-3112 (WHEN REQ'D)
 MATERIAL: SIDE PC. FRAMES - CAST GRAY IRON ASTM A-48, CLASS 35A
 END PC. FRAMES AND GRATES - CAST GRAY IRON ASTM A-48, CLASS 35B
 FINISH: NO PAINT UNLESS SPECIFIED ON PURCHASE ORDER

DR.	CAG	SCALE	TITLE
CH.	RKB	1/8"=1'	R-4990-CX
APP.	SPT		TYPE "B" FRAME WITH TYPE "Q" GRATE
DATE	6/2/2014		
www.aenechfoundry.com		 NEENAH WISCONSIN 54956 PHONE 800-558-5075 LINCOLN, NEBRASKA 68529 PHONE 800-234-7468	
			NF-4990CX Q B

R-4990 HEAVY DUTY TRENCH

Materials: All frames and grates/lids are furnished standard in gray iron, meeting ASTM-A48 Class 35-B for heavy-duty use. For extra heavy-duty use or superior durability requirements, see our ductile iron Airport and Port Grating Series on page 286.

Neenah recommends project designers avoid the use of light duty trench installations because it is likely that applications will be subjected to heavy delivery vehicle traffic at some time. Furthermore, the use of a site could be changed to heavy duty use patterns at some unanticipated future date.

Dimensions in inches

Un-Bolted Catalog No.	A	B	C	Type A	Type C	Type D	Type E	Type P	Type Q
R-4990-AX	8	1 1/2	6	x	x	x	x	x	
R-4990-BX	10	1 1/2	8	x	x	x	x	x	
R-4990-CX	12	1 1/2	10	x	x	x	x	x	x
R-4990-DX	14	1 1/2	12	x	x	x	x	x	x
R-4990-EX	17	1 1/2	15	x	x	x	x	x	
R-4990-FX	20	1 1/2	18	x	x	x	x	x	
R-4990-GX	23	1 1/2	21	x	x*	x			
R-4990-HX	26	1 1/2	24	x	x*	x	x		x
R-4990-JX	30	2	27	x	x	x			
R-4990-KX	33	2	30	x	x	x*	x		
R-4990-LX	36	2	33	x	x	x*			
R-4990-MX	39	2	36	x	x*	x			
R-4990-NX	45	2	42	x	x*	x			
R-4990-OX	51	2	48	x		x*			

x - Indicates availability.

* Deep Ribs (consult shop drawing for dimensions).

Deep Ribs = "B" dimension times 2 or greater.

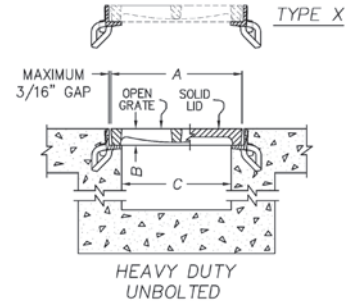

General schematic shown may not apply to all designs. Bar and rib depths, plate thicknesses and seating widths vary on different sizes and styles. If your project has design restrictions, contact your sales representative or product engineering.

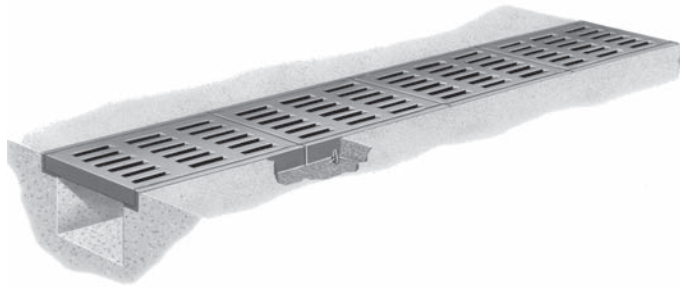

Illustrating Type C trench. Trench sections are furnished in 24" standard lengths.

Note: In Type A and P grates the slots are perpendicular to the trench run. In Type C and Q grates the slots are parallel with the trench run.

Read Carefully Before Ordering

The various standard trench drains are available with a number of alternatives. It is important to examine all of the variables carefully and specify your requirements fully. Your order will be entered correctly and promptly if it includes the following information:

- Complete catalog number
- Frame end pieces, when required
- Type of Lid or Grate: A, C, D, E, P or Q
- Length of trench sections
- Angles and intersections *
- Load requirements

*Trenches with angles, intersections, size changes or other special requirements require detail drawings prior to ordering. Contact your sales representative or product engineering for assistance.

800-558-5075

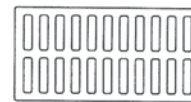

TYPE A
GRATE OPENINGS

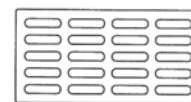

TYPE C
GRATE OPENINGS

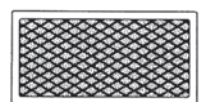

TYPE D
SOLID LID

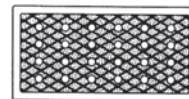

TYPE E
VENTED LID

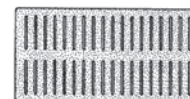

TYPE P
GRATE OPENINGS

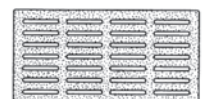

TYPE Q
GRATE OPENINGS

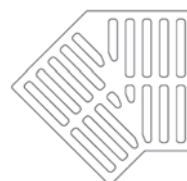

TYPE A
45 DEGREE
INTERSECTION PC.

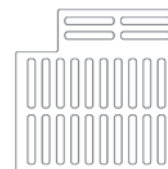

TYPE A
90 DEGREE
INTERSECTION PC.

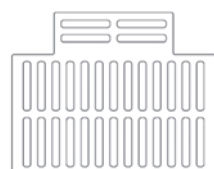

TYPE A
"T" INTERSECTION PC.

Note: 45°, 90° and "T" available in limited sizes and types.

Suggested Forming Instructions for R-4990 Frame and Grate/Lid

Unbolted Units

A typical installation is shown in Figure 1. Details and suggestions are based on using the Neenah Foundry Type X Frame.

Materials

Under normal situations, use 3/4 inch plywood for forming walls. 2x4s are suitable for studs, plates, bracing and spreaders.

Forming Procedures

Pour the floor slab of the trench according to the plans and specifications. The width of the forming, (see Figure 2) measured from the outside edges of the forms, corresponds to the "C" dimension on Figure 1. During the entire forming procedure, verify that the forms are plumb, straight, solid and level.

The height of the form corresponds to the final grade elevation. Extend the spreaders beyond the edge of the forms (see Figure 3 and 4) to provide a stop for the frame and seat form.

To attach the cast iron frame to the forming, the use of a "seat form" is recommended to assure that the frame is at the proper elevation and true. The seat form has the same dimensions as the frame, with the height corresponding to the frame height (the "B" dimension), and the width the same as the seat width of the frame. The seat width should be field measured to assure as proper fit. All Neenah frames have a slight radius at the corner of the seat and vertical face so the seat form should be beveled to accommodate the radius. Most 2x4's have this radius.

Nail the seat form to the frame using the holes in the frame. (Figures 3 & 4)

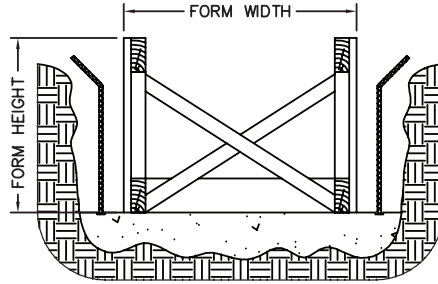
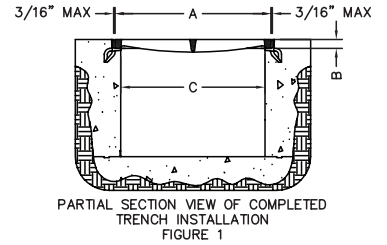

FIGURE 2

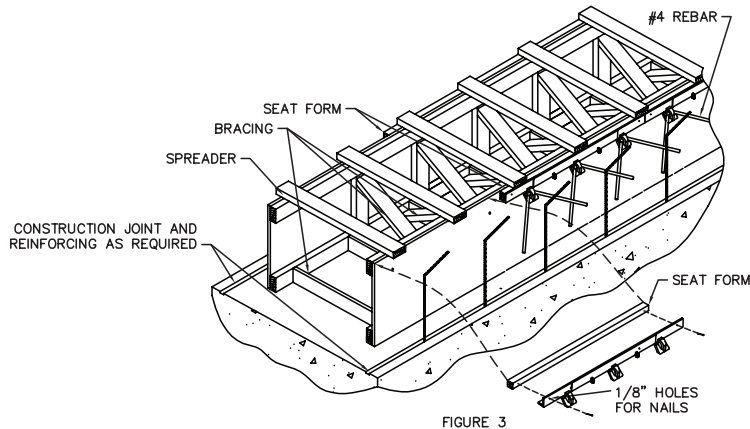

FIGURE 3

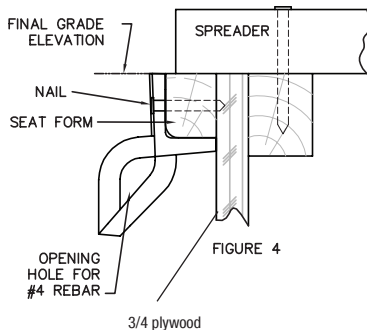

FIGURE 4

(The rebar shown in the vertical walls of the trench is for illustrative purposes only. Proper sizing and placement is the responsibility of the engineering firm providing the project design.)

Frames should butt together snugly, leaving as little gap as possible. Place a 90 degree bent #4 rebar through the holes in the anchor lugs to provide anchorage in the concrete. Verify the space between the edges of the grate and frame so grates will fit properly. There should be a gap but no greater than 3/16" (see Figure 1).

Pour concrete and use the top edge of the frame as a screed point.

Supplied By:

**TRENCHDRAIN
SUPPLY**

877-903-7246

www.trenchdrainsupply.com